

Central Wyoming College Organizational Chart

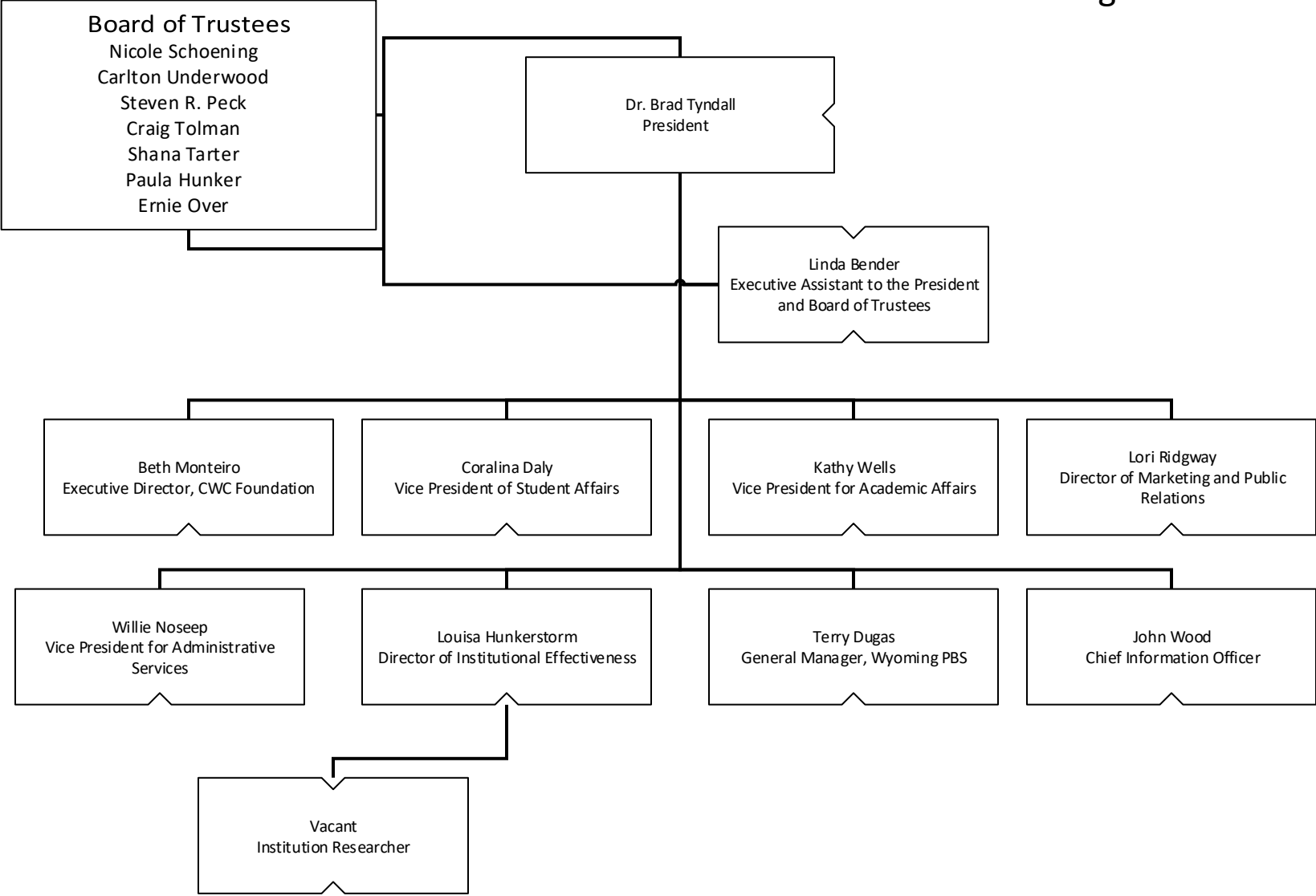

Foundation

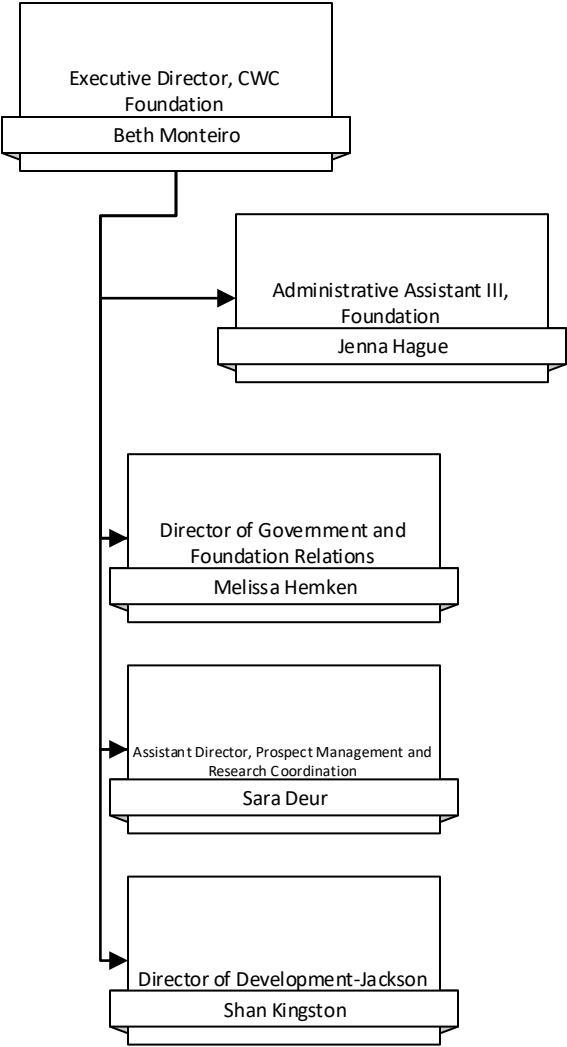

Marketing & Public Relations

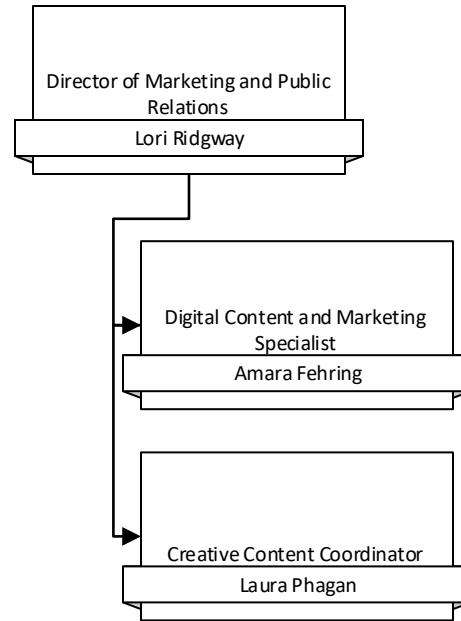

Student Affairs

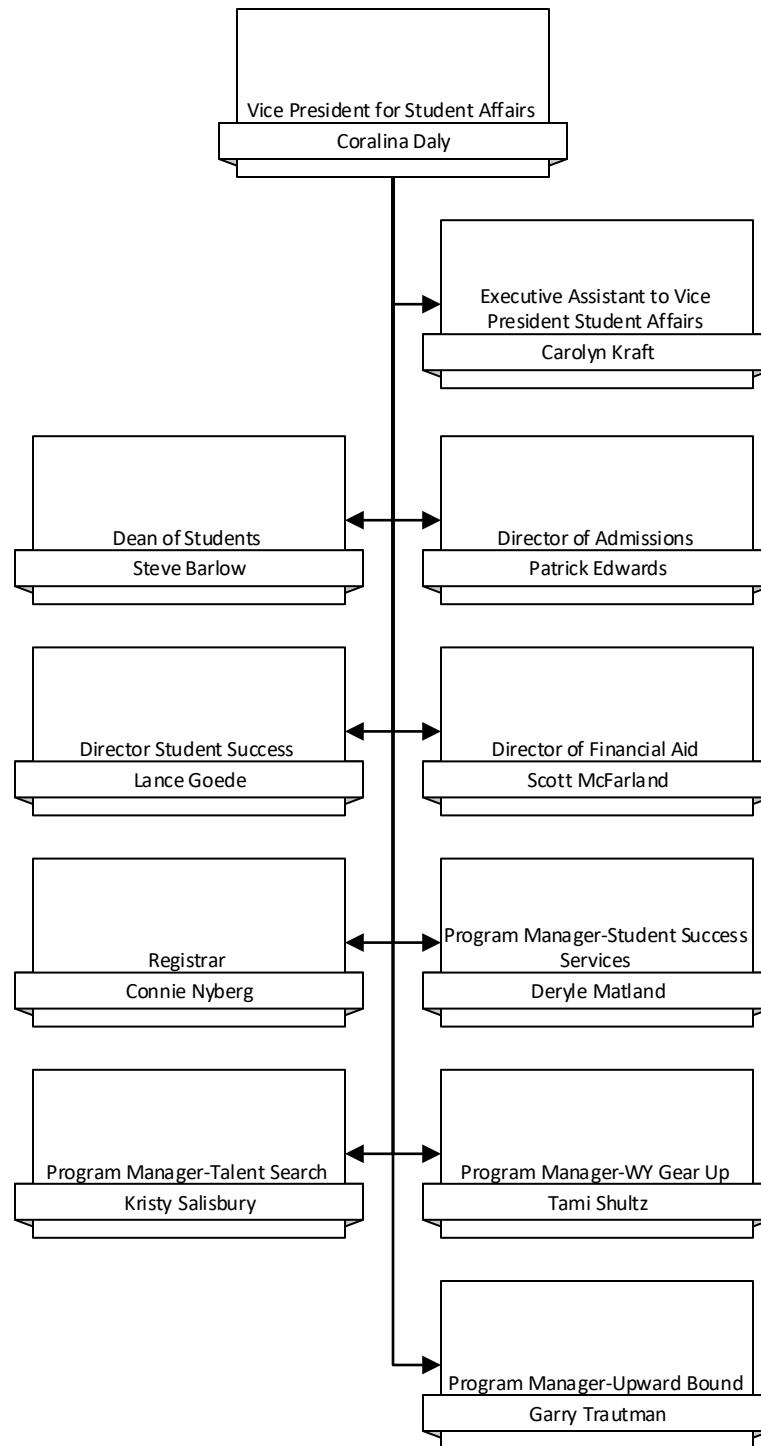

Student Affairs, Continued

- Athletics
- Residential Life
- Outreach-Dubois
- Lander Center
- Student Life Leadership
- Community Education

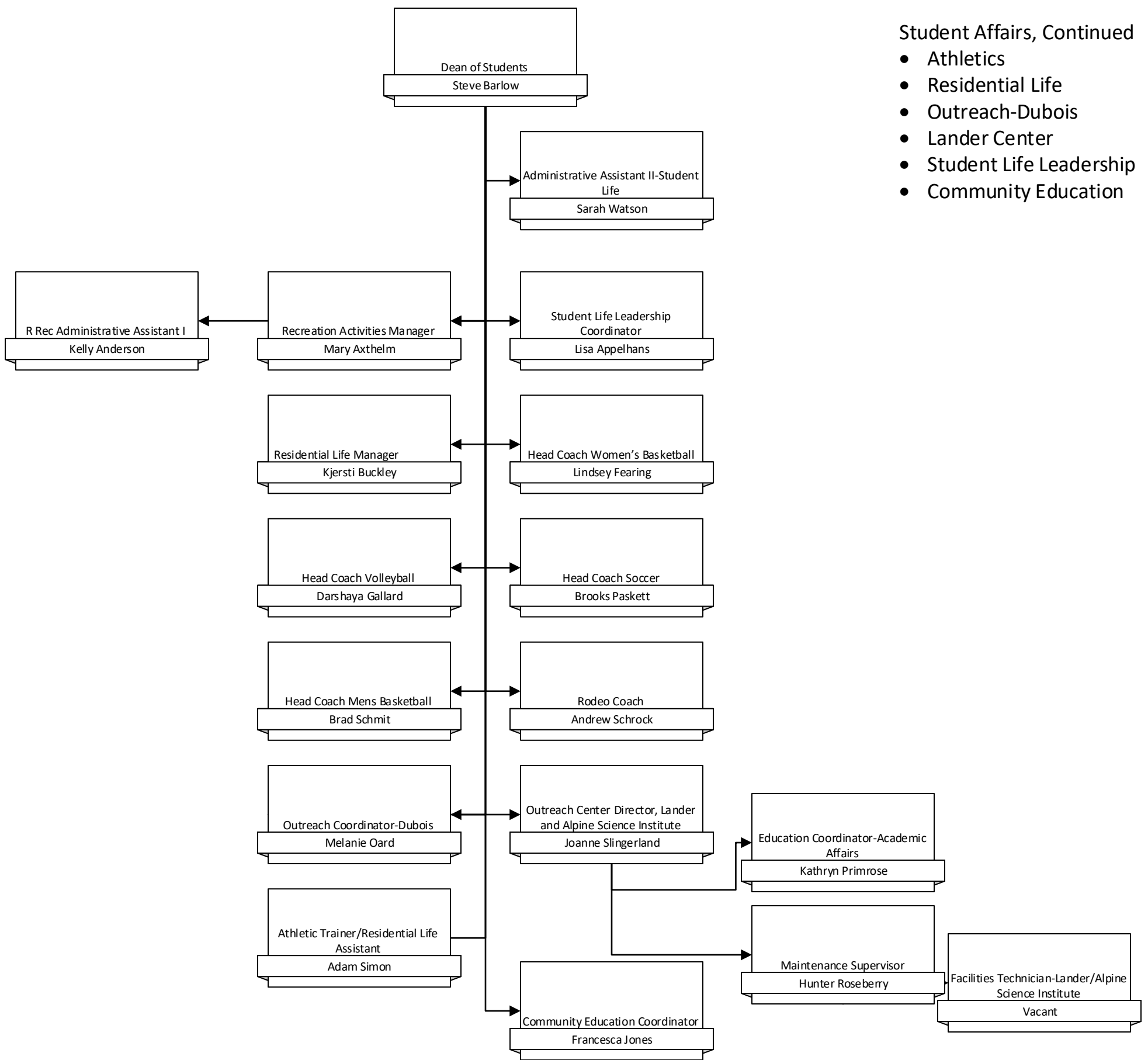

Student Affairs, Continued

- Admissions
- Student Success
- Financial Aid

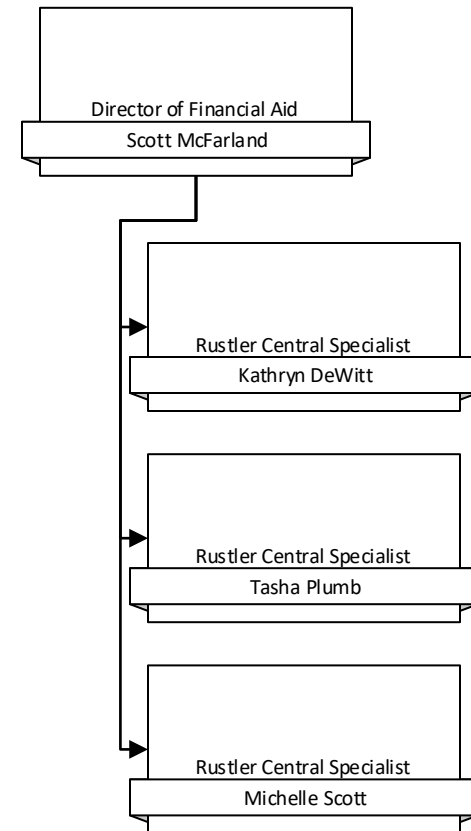
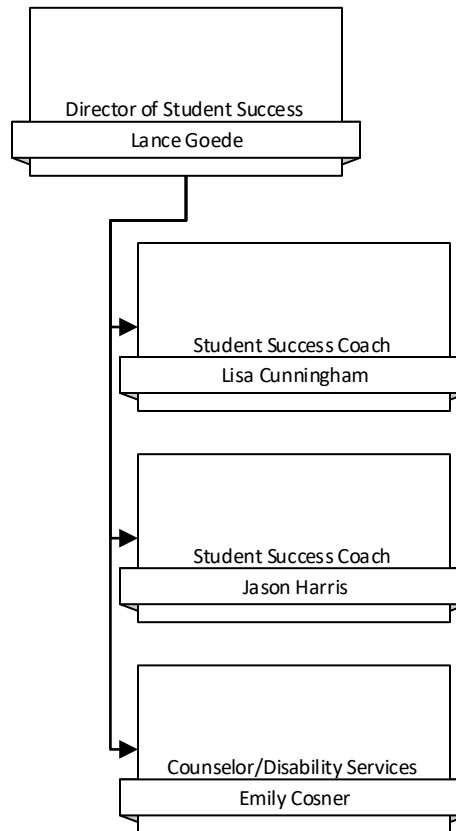
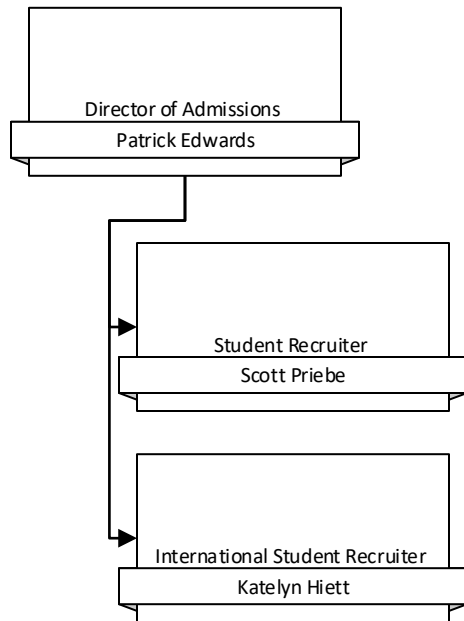

Student Affairs, Continued

- Registrar
- Student Success Services
- Upward Bound
- WY Gear Up
- Talent Search

Registrar
Connie Nyberg



Student Record Specialist
Kristin Wallage

Rustler Central Assistant
Brenda Barlow

Rustler Central Assistant
Pauline Hodgson

Rustler Central Virtual Assistant
Jody Goodrich

Program Manager-Student Success Services
Deryle Matland



Tutor/Skills Coach
Whitney Martinez

Education/Transfer Coach
Paula Hartbank

SSS Education/Retention Coach
Matthew Myers

Program Manager-WY Gear Up
Tami Shultz



Administrative Assistant II-WY Gear Up
Renee Fullerton

WY Gear Up Curriculum Coordinator
Joy Pettit

Program Manager-Talent Search
Kristy Salisbury



Grant Support Specialist
Marchia Himes

Program Manager-Upward Bound
Garry Trautman



Upward Bound Curriculum Coordinator
Thomas Nirider

Academic Affairs

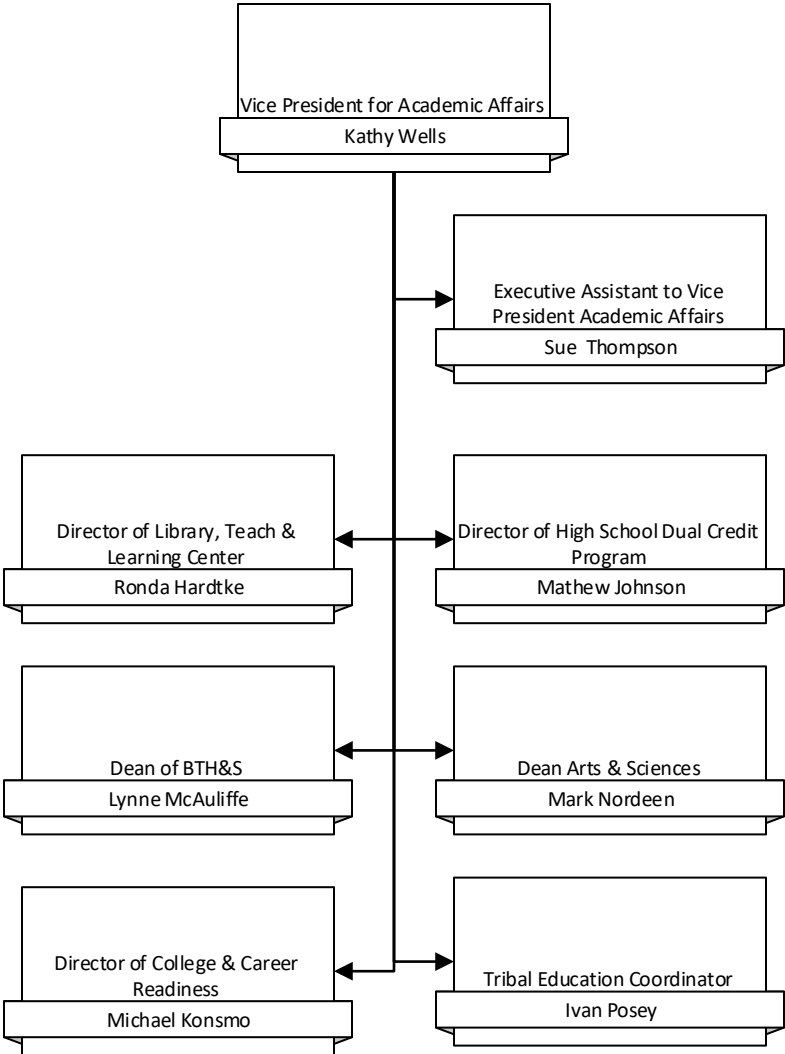

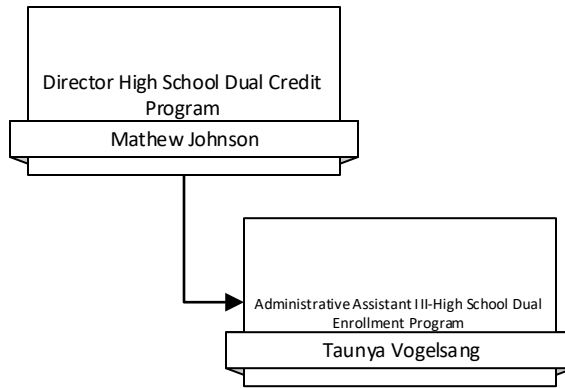
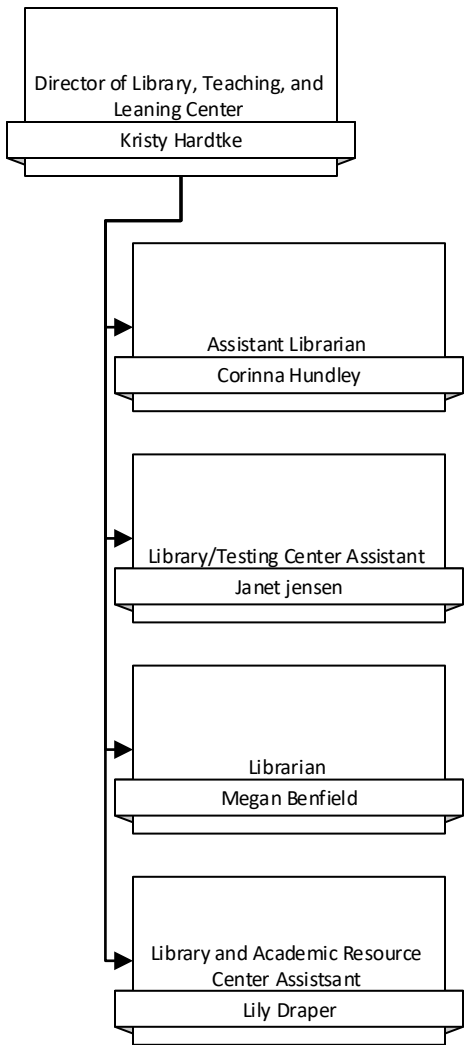

Academic Affairs, Continued

- Library
- High School Dual Credit Program

Academic Affairs, Continued Business, Technical, Health and Safety

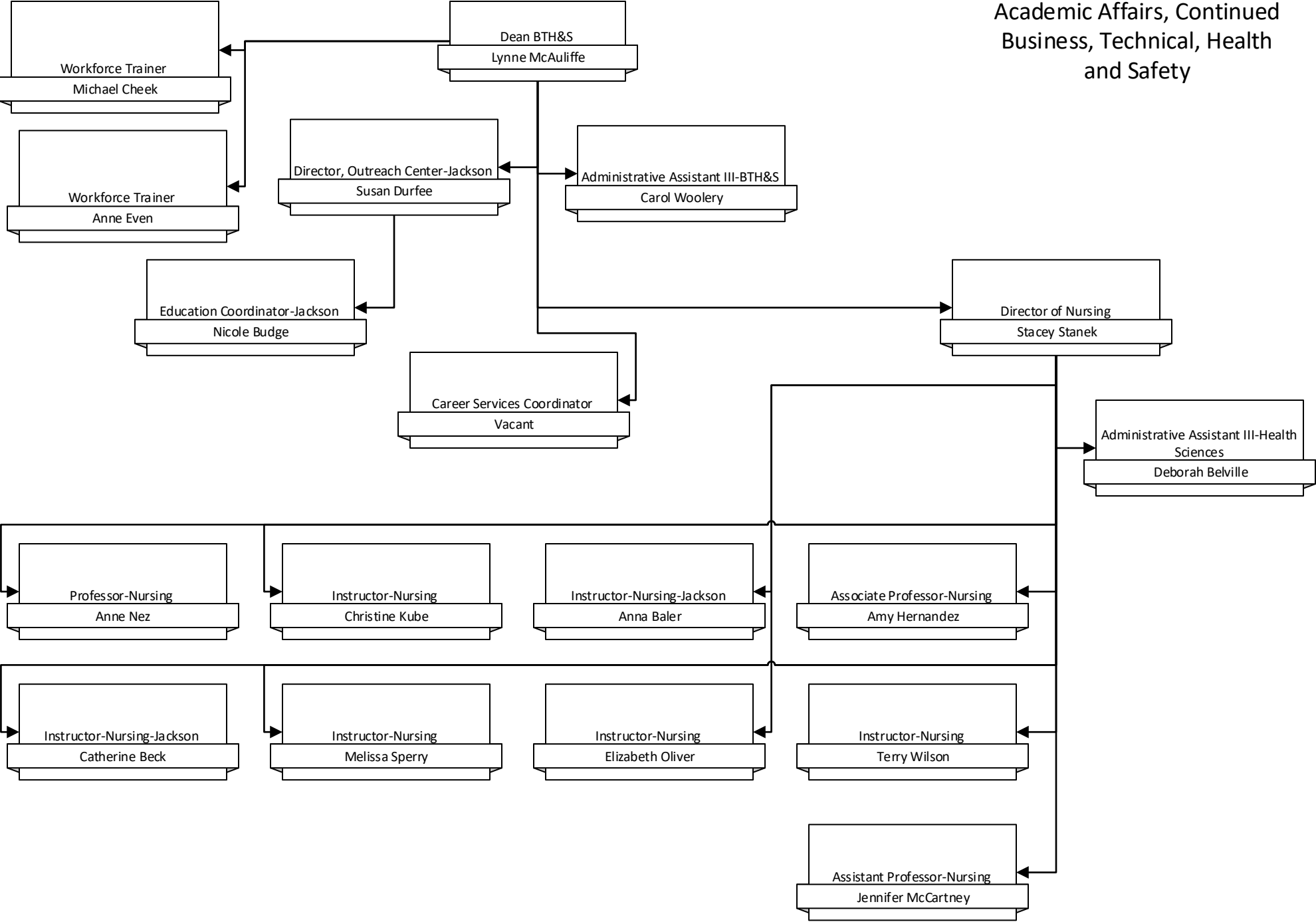

Academic Affairs, Continued
 Business, Technical, Health
 & Safety Faculty

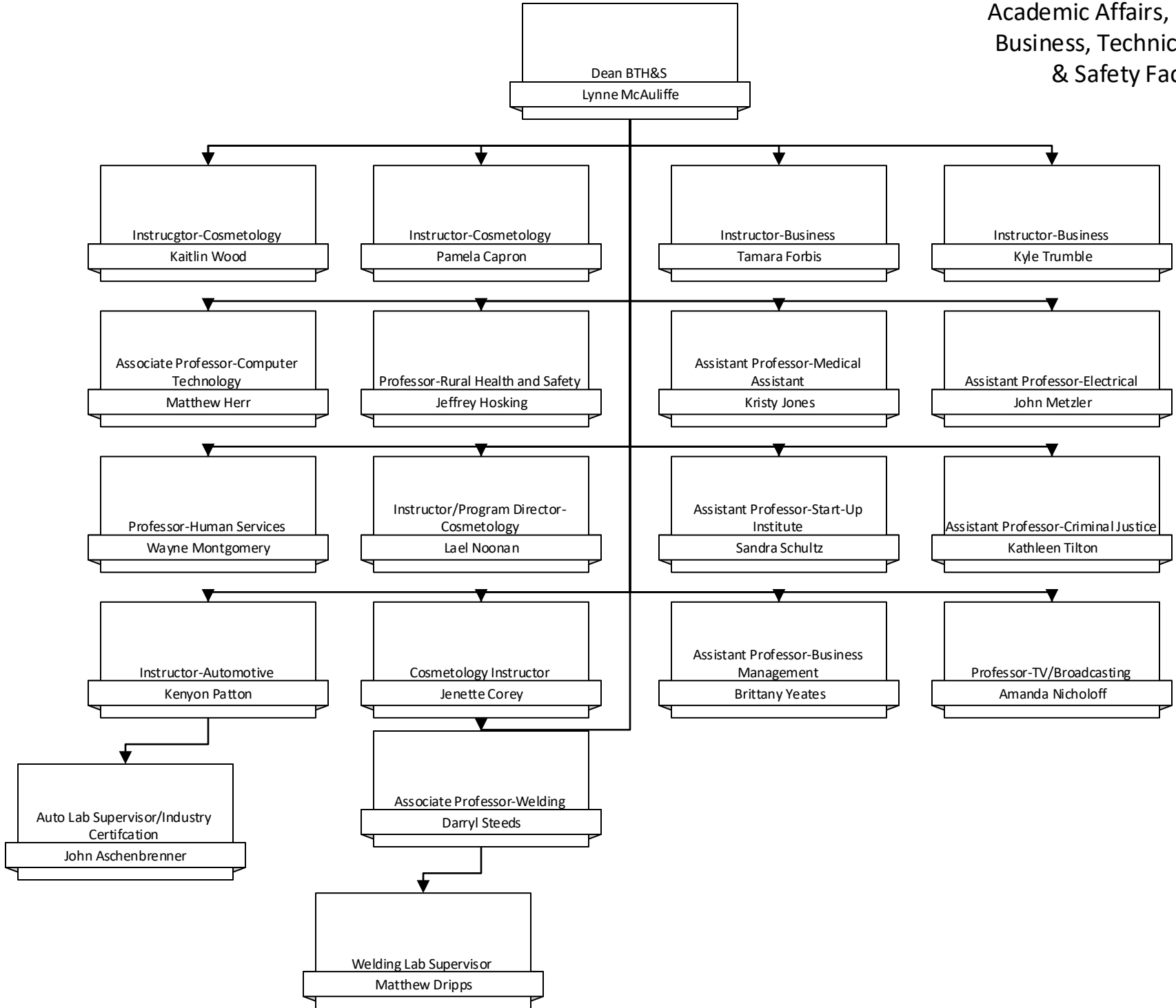

Academic Affairs, Continued
Arts & Sciences

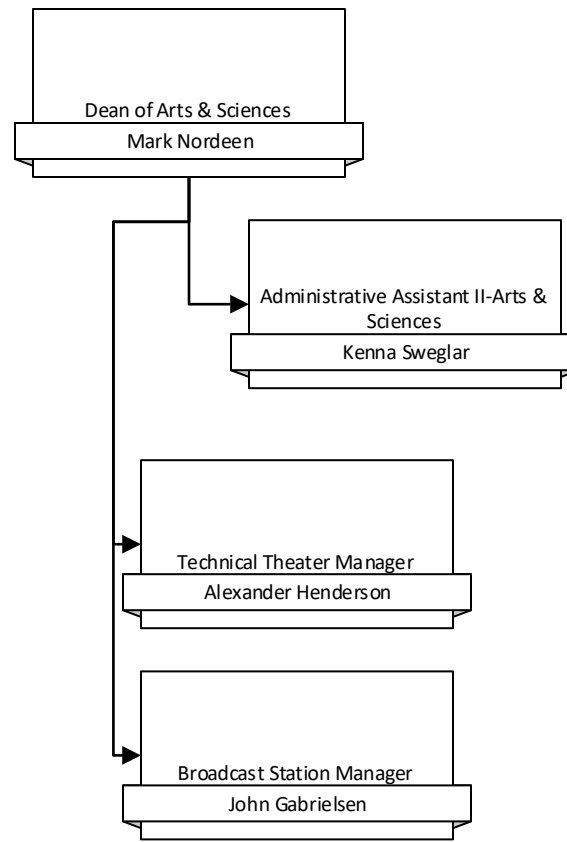

Academic Affairs, Continued
Arts & Sciences Faculty

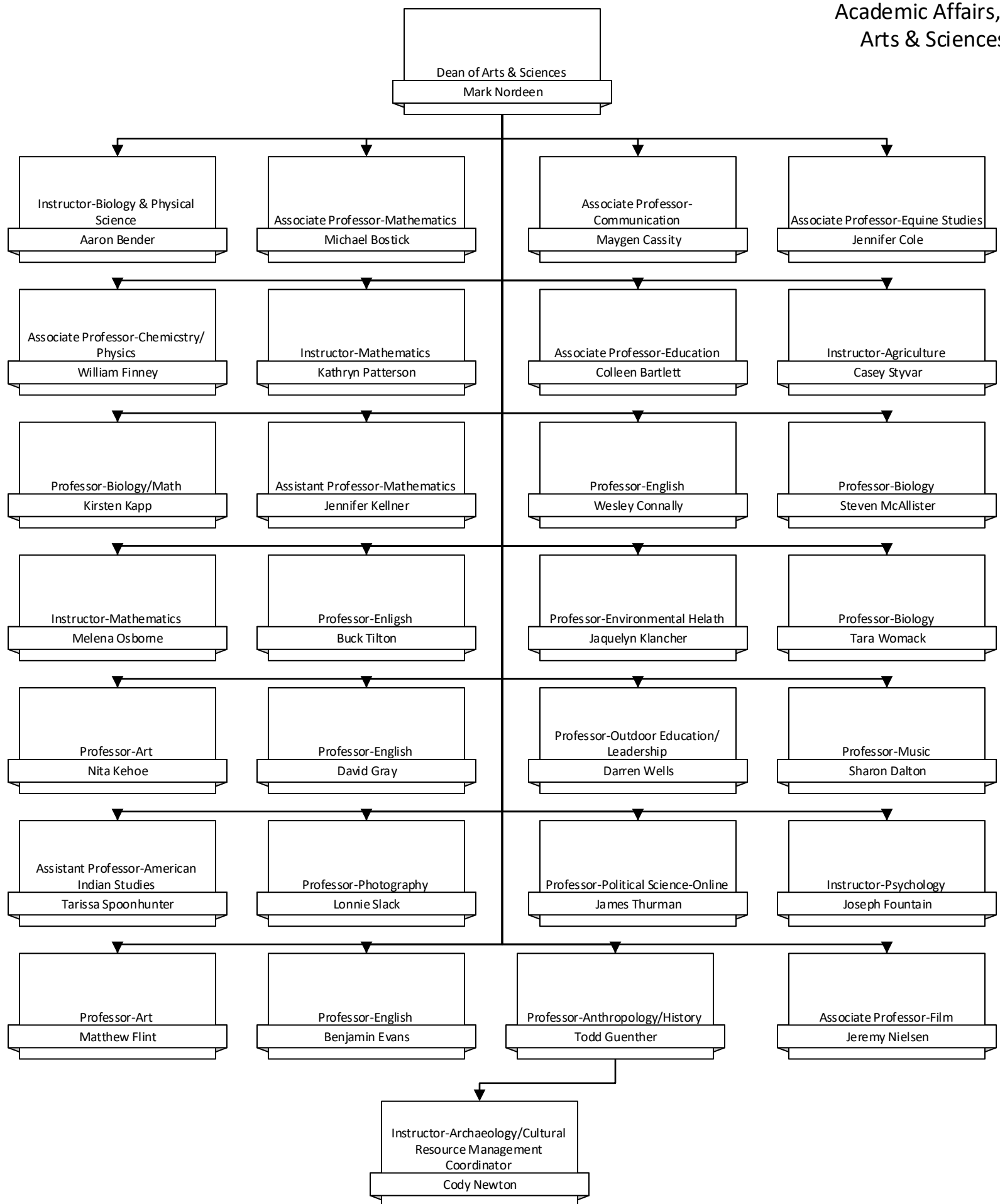

Academic Affairs, Continued

- College & Career Readiness

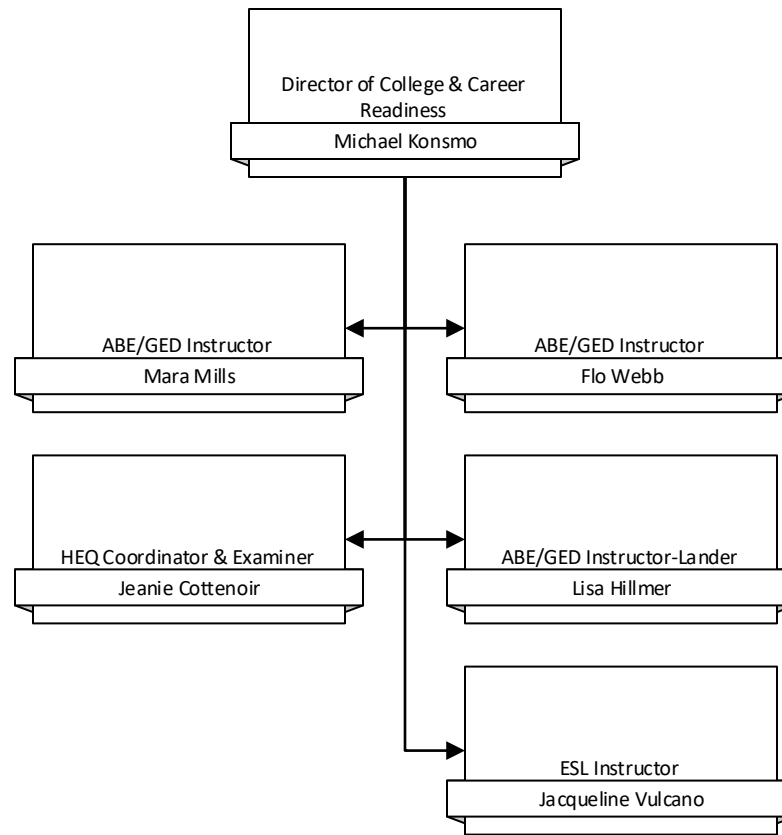

Administrative Services

- Campus Safety
- Finance
- Human Resources
- Payroll
- Food Services
- Physical Plant
- Facility Scheduling
- Bookstore
- Mailroom
- Barista

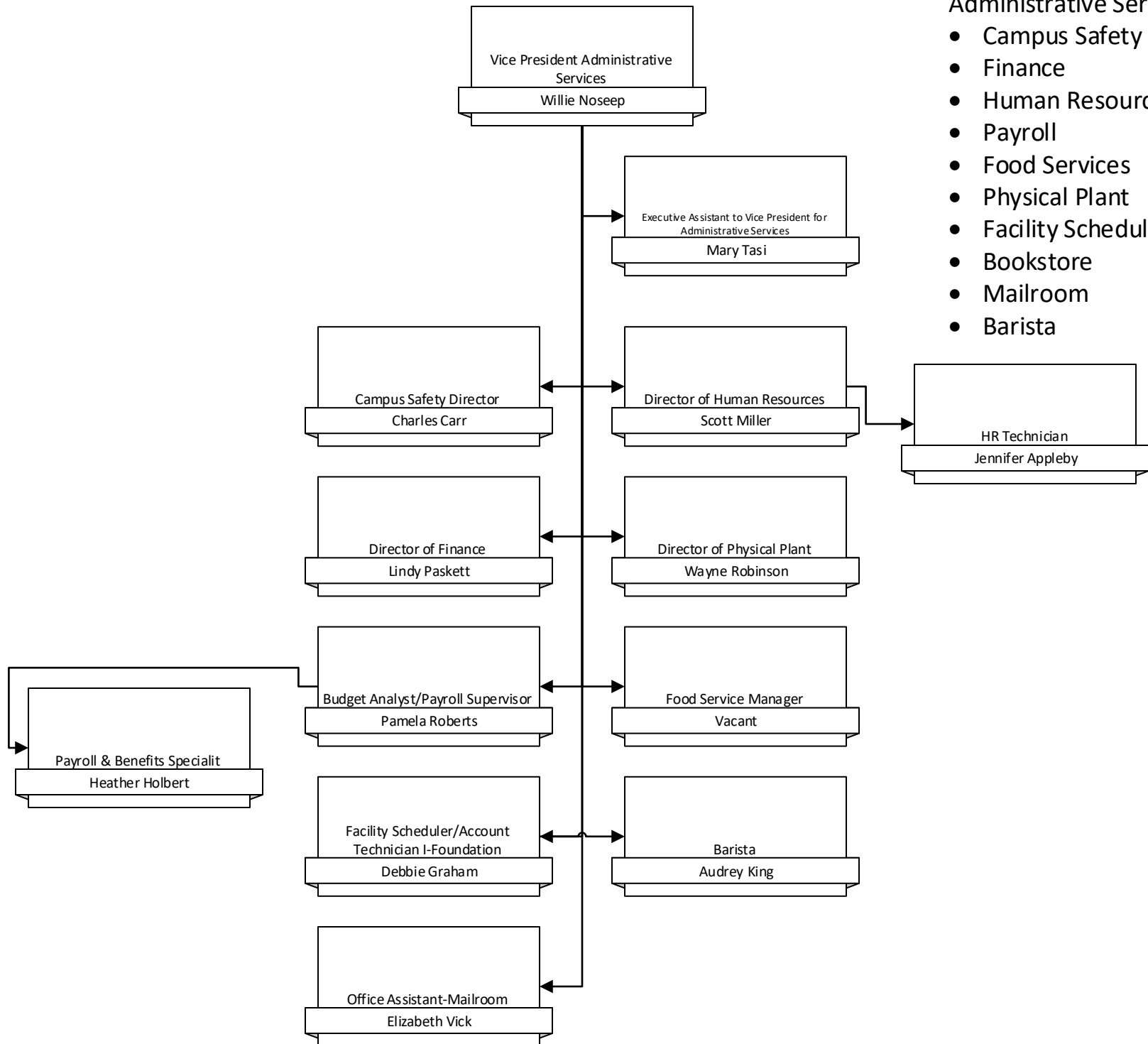

Administrative Services, Continued
Physical Plant

Director-Physical Plant
Wayne Robinson

Maintenance Supervisor
Kirk Clark

Custodial Foreman
Shelley Dolbow

Custodian
Elaine Heckert

Maintenance Technician II-HVAC
Robert Gonzalez

Maintenance Technician I
Brian Mason

Maintenance Technician II-
Electrical
Earland Thompson

Maintenance Technician I/
Locksmith
Steve Mason

Equine Center Operations
Technician
Joel Butters

Operating Manager-Equine Center
Michael Donelson

Grounds Technician
Kirck Kariker

Grounds Supervisor
Stefan Petersen

Grounds Assistant/Vehicle
Technician
Andy Titus

Campus Services Foreman
Bart Reynolds

Campus Services Foreman
Michael McLean

Facilities Attendant
Bruce Coleman

Facilities Attendant
William Bowen

Custodian
Jesse Conover

Facilities Attendant
Alan Hall

Facilities Attendant
Douglas Swenson

Custodian
Gwenn Connor

Custodian
Valorie Hejny

Custodian
Danette Marone

Custodian
Jeffrey Garner

Custodian
Bryon Throckmartin

Custodian
Josh Appleby

Facilities Attendant
Laurel McCart

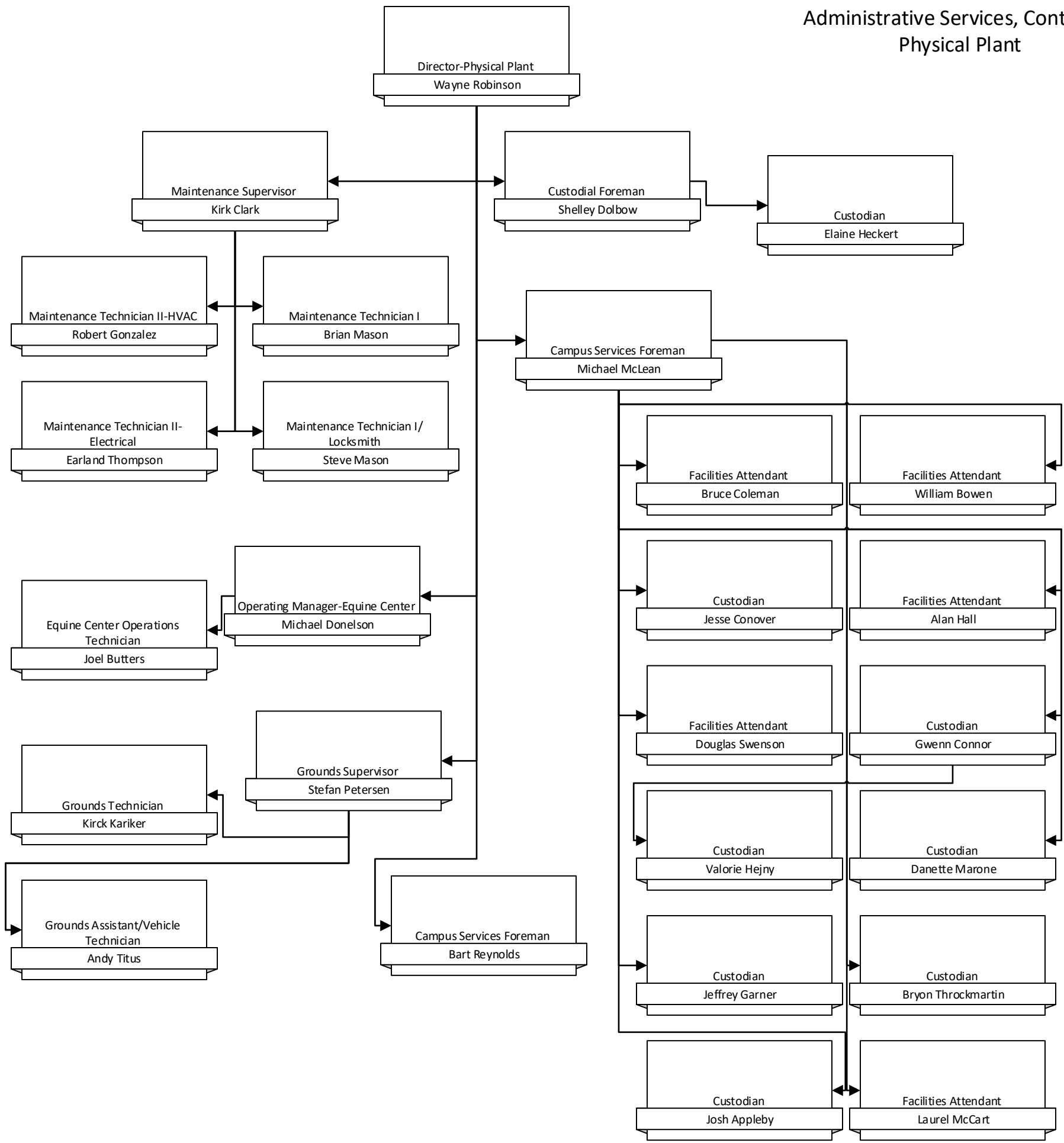

Administrative Services, Continued
Finance

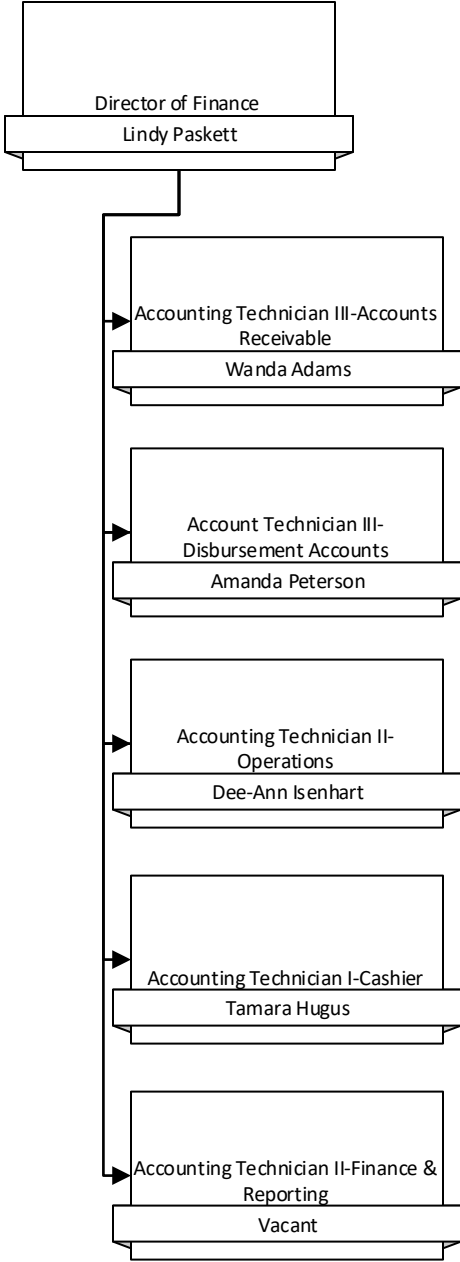

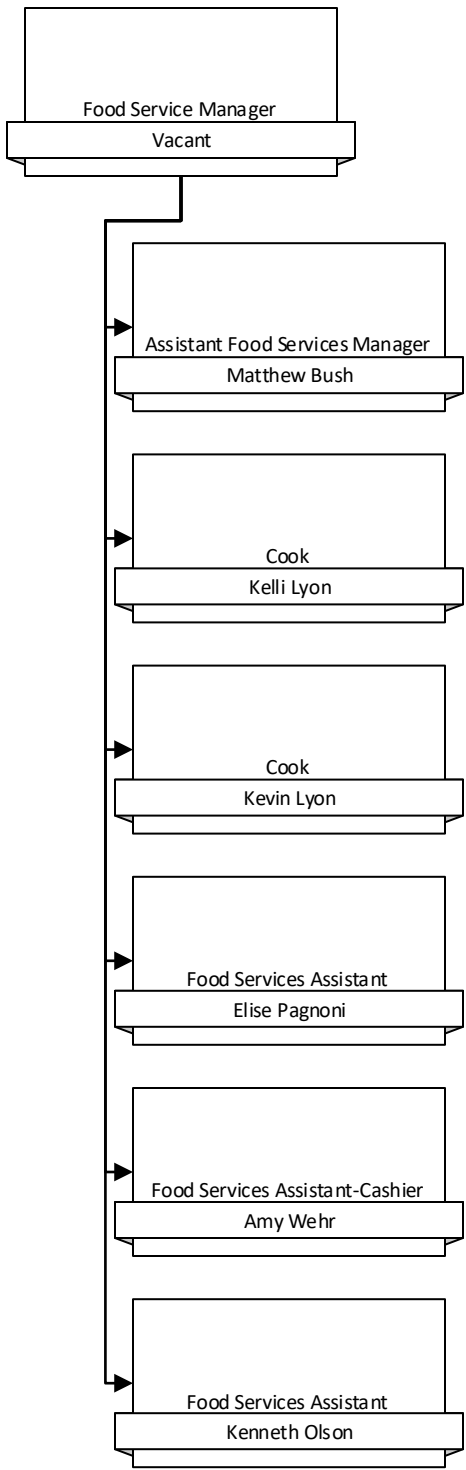
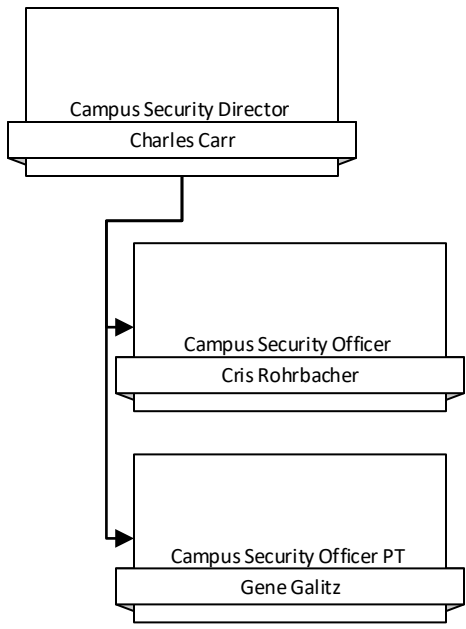

Administrative Services, Continued

- Campus Safety
- Food Service

Information Technology

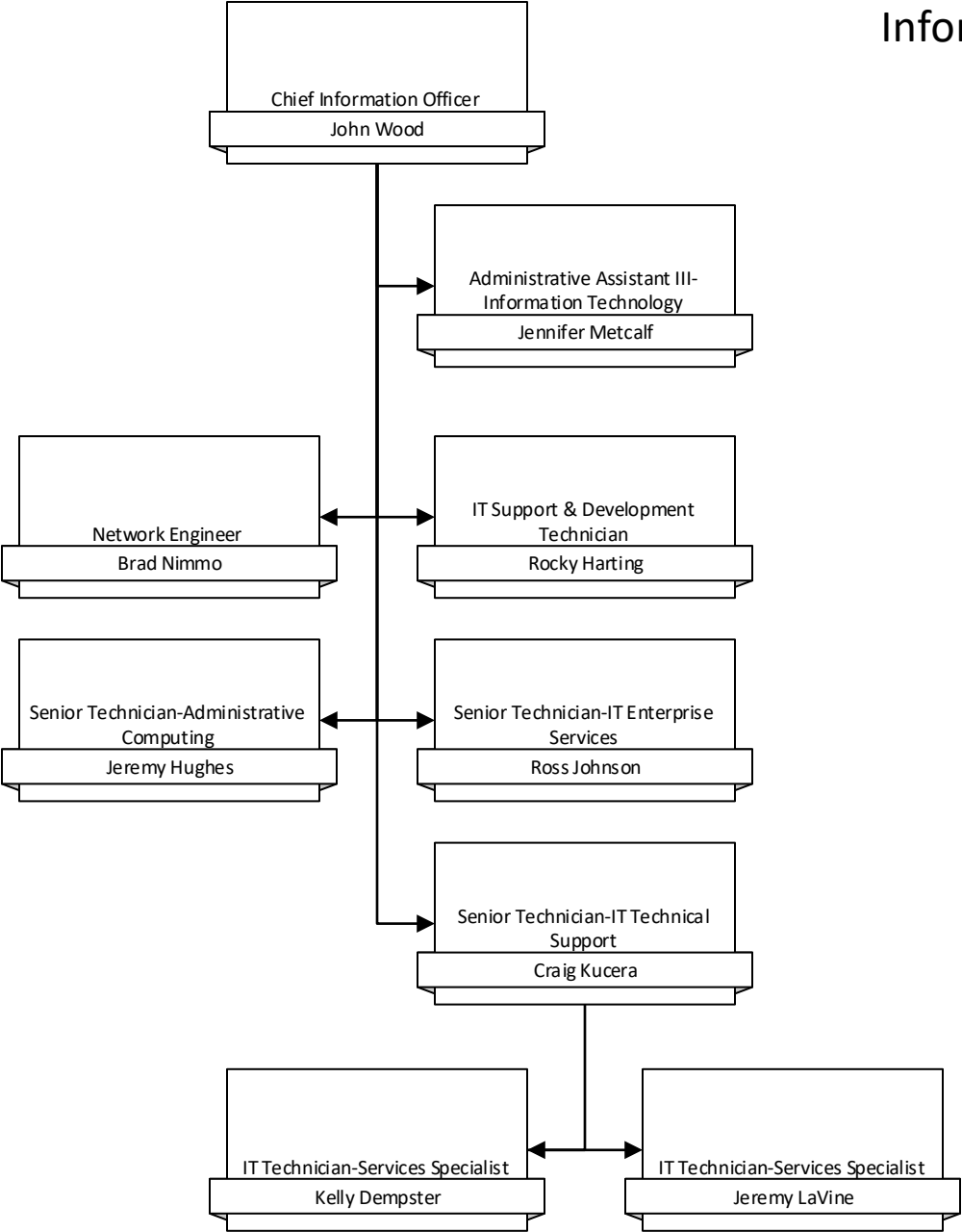

Wyoming Public Broadcast System

